

WS-2810U-IT Wireless Professional Weather Center

Operations Manual

TABLE OF CONTENTS

TABLE OF CONTENTS.....	2
INTRODUCTION.....	5
INVENTORY OF CONTENTS.....	6
FEATURES.....	7
Wireless display.....	7
Thermo-hygro sensor.....	7
Wind sensor.....	8
Rain Sensor.....	8
SET UP.....	8
MOUNTING AND PLACEMENT OF THE SENSORS AND WIRELESS DISPLAY.....	9
Wind sensor.....	10
Rain sensor.....	10
Thermo-hygro sensor.....	11
Display and Heavy Weather Pro PC software.....	11
FUNCTION KEYS.....	11
SET key.....	11
▲ UP ARROW key.....	12
▼ DOWN ARROW key.....	12
ALARM Key.....	12
MIN/MAX key.....	12
Mode 1 display.....	12
Mode 2 display.....	13
Date or seconds display mode.....	13
LCD SCREEN.....	13
MANUAL SETTINGS.....	14
LCD contrast.....	14
Manual Time.....	14
12/24-hour time.....	15
Date.....	15
°F/°C temperature unit.....	15
Wind speed unit.....	16
Rainfall unit.....	16
Relative air pressure unit.....	16
Relative pressure reference value.....	16
Weather tendency sensitivity.....	17
Storm warning threshold value.....	17
Storm Alarm on (AON) or off (AOFF).....	17
Wind direction display type.....	18
Factory reset process.....	18
Exit manual set mode.....	19
WEATHER ALARM OPERATIONS.....	20

The following Weather Alarms can be adjusted in ALARM set mode.....	20
Default Weather Alarm values.....	20
Pressure Alarms.....	21
Indoor Temperature Alarms.....	21
Indoor Humidity Alarms.....	22
Outdoor Temperature Alarms.....	22
Outdoor Humidity Alarms.....	23
Wind Gust Alarm.....	23
Wind Direction Alarm.....	24
24-hour Rainfall Alarm.....	24
HYSTERESIS.....	25
WEATHER FORECAST AND WEATHER TENDENCY INDICATORS.....	25
Weather Forecast Icons.....	25
Weather Tendency Indicator.....	26
AIR PRESSURE HISTORY GRAPH.....	27
WIND DIRECTION AND WIND SPEED MEASUREMENT.....	28
RAINFALL MEASUREMENT.....	28
VIEW THE MIN/MAX WEATHER DATA.....	29
Reset the MIN/MAX weather data.....	29
Reset Total Rainfall.....	29
CARE AND MAINTENANCE.....	30
SPECIFICATIONS.....	30
Indoor temperature.....	30
Indoor humidity.....	30
Outdoor temperature/dew point.....	31
Outdoor humidity.....	31
Wind speed/gust.....	31
Wind chill.....	31
Rainfall.....	32
Outdoor Data Reception.....	32
Air Pressure.....	32
Transmission range.....	32
Power consumption.....	33
Weather Center.....	33
Thermohygro transmitter.....	33
Rain sensor.....	33
Wind sensor.....	33
Battery life.....	33
LIABILITY DISCLAIMER.....	34
FCC STATEMENT.....	34
WARRANTY.....	36

Congratulations on purchasing this state-of-the-art weather station. Featuring time, date, weather forecast, wind gust and wind speed, indoor/outdoor temperature and humidity, air pressure and rainfall, this weather station will provide various weather information and weather forecasts.

Heavy Weather Pro software allows you to use a PC to monitor and record weather data received from the La Crosse Technology® wireless weather station via a proprietary USB device that was provided with the 2800 series weather station.

Monitor and record a variety of data collected by the weather station including both indoor and external values sampled by the various weather station sensors.



Review weather history data, and analyze trends and tendencies over time using the software's charts and graphing features, or export the data to a text file.

Read the Release Notes to verify the correct and most current software version and download the free Heavy Weather Pro PC software at:

<http://www.lacrossetechnology.com/support/software.php>

INVENTORY OF CONTENTS

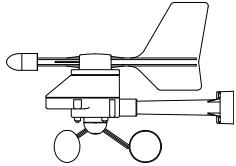
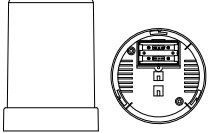
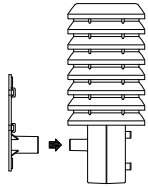
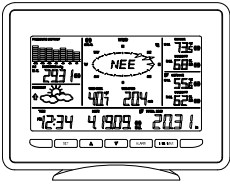
Carefully open the package and check that the following contents are complete:

Wind Sensor TX56UN-1-IT	Rain Sensor TX58UN-IT	Thermo-Hygro Sensor TX59UN-1-IT	Wireless Display WS-2810U-IT	USB Transceiver USBTRX-10
 <ul style="list-style-type: none"> • Mast holder • Right angle adaptor • 1 x U-bolts • 2 Washers + 2 Nuts • Plastic Reset Rod • Contains solar rechargeable alkaline power cells. (not replaceable) 	 <ul style="list-style-type: none"> • Base sensor, funnel top cover and battery cover (pre-assembled) • Requires 2-AA alkaline batteries (not included) 	 <ul style="list-style-type: none"> • Airflow cover • Wall mount adapter • Mounting screws • Plastic anchors for screws • Requires 2-“C” alkaline batteries (not included) 	 <ul style="list-style-type: none"> • Detachable stand • Requires 3 “C” alkaline batteries (not included). 	 <ul style="list-style-type: none"> • USB wireless interface for PC
<p>Wind Sensor also Protected under U.S. Patent: 6,761,065</p>	<p>All items, including Wind Sensor, are Protected under U.S. Patents: 5,978,738; 6,076,044; & 6,597,990</p>			

INSTANT TRANSMISSION is the state-of-the-art new wireless transmission technology,

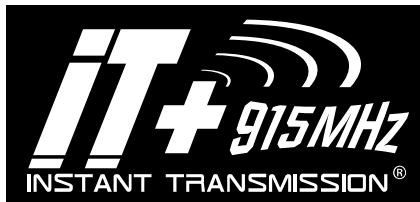

exclusively designed and developed by La Crosse Technology®. *INSTANT TRANSMISSION* offers you an immediate update of all the outdoor data measured from the transmitters: follow the climatic variations in real-time!

FEATURES:

WIRELESS DISPLAY

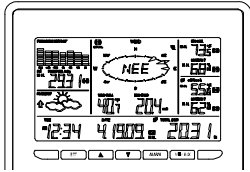

- Time display in 12/24 hour time format
- Automatic time and date (PC time) update from USB transceiver if connected; otherwise, user must manually set
- Calendar display (date, month, year)
- Weather forecast with 3 weather icons (sunny, cloudy, and rainy) with weather tendency indicator
- Temperature display in °F/°C: from -39.8°F to 139.8°F
- Humidity display in RH%: from 1% to 99%
- Dew point display in °F/°C: from -39.8°F to 139.8°F
- Wind chill display in °F / °C: down to -39.8°F
 - Wind chill value is calculated from outdoor temperature and wind velocity values.
- MIN/MAX values of indoor/outdoor temperature, indoor/outdoor humidity, dew point display with time and date of recording
- Relative air pressure reading in inHg/hPa: preset range 27.10 to 31.90 inHg
- 24h/72h selectable pressure history graph
- Wind speed displayed in mph, km/h, m/s, knots, and Beaufort scale: 0 to 111.8 mph
- Wind speed & direction with LCD compass display (16 steps/ 22.5 degree)
- MAX records for wind gust with time & date of recording
- Rainfall display in inch/mm: from 0" to 393.6"
- Rainfall data for total rain, last hour, last 24h, last week, last month
- Weather alarm modes: temperature, humidity, wind gust, wind direction, air pressure, 24h rain and storm warning
- Buzzer on/off select
- LCD contrast setting
- Storage of 1750 sets of weather records with user selectable recording interval from 1 minute to 24 hours

THERMO-HYGRO SENSOR

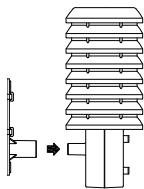

- Transmission of temperature and humidity data.
- Requires 2-“C” alkaline batteries (not included)
- Transmission range: 200 feet (Open field, free of obstructions)

WIND SENSOR

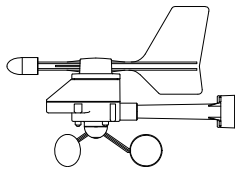

- 100% solar-powered with built-in rechargeable alkaline power cell (not replaceable).
- High-efficient solar panels maintain operation throughout all seasons
 - Transmission range: 200 feet (Open field, free of obstructions)

RAIN SENSOR

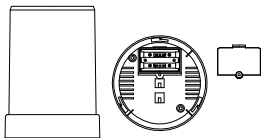

- Self-emptying bucket
- Requires 2-AA alkaline batteries (not included)
 - Transmission range: 200 feet (Open field, free of obstructions)

SET UP:

IMPORTANT: Make sure to observe the correct polarity when inserting batteries. The "+" markings on the batteries must line up with the diagrams inside the battery compartments. **Inserting the batteries incorrectly may result in permanent damage to the units.** During the setup process, place the wireless display and the outdoor sensors on a surface with 5-10 feet between the sensors and the display. **Only use Alkaline Batteries, rechargeable batteries may not work.**

1. It is important to allow sufficient light to reach the solar panel while activating the wind sensor. Make sure the lights are on in the setup room and the solar panel is facing a 60W light bulb or brighter. Ensure the panel is not covered, and remove the black protective foil on the solar panel. Remove the tape covering the reset hole. Use the provided plastic reset rod to gently press the reset button once in the hole on the bottom of the sensor.
2. Insert two "AA" size batteries into the rain sensor with the correct polarity.
3. Insert two "C" size batteries into the thermo-hygro sensor with the correct polarity. **Wait two minutes** for the sensors to talk to each other.
4. Insert three "C" size batteries into the wireless display with the correct polarity. Do not press any button for 10 minutes.

Press Reset Button on Bottom of Wind Sensor (Solar Panel Must Face Light)

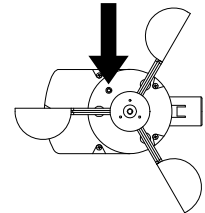

NOTE: Every time the wireless display receives data from the sensors, the wireless icons ☁ will blink once and then return to solid if the last transmission was successful. A wind speed or rainfall amount that reads "0" does not mean reception failure, it means that there was no wind or rain at the time of the last measurement. The thermo-hygro sensor syncs with the wind and rain sensors and sends all outdoor sensor data to the display. The thermo-hygro sensor tries for 4 minutes to sync to the wind sensor and

then 4 minutes for the rain sensor. If not successful within 4 minutes, the thermo-hygro sensor will stop looking for the other sensors.

5. **Setup troubleshooting:** If the sensor data fails to display for any of the outdoor sensors within 10 minutes, (“- - -” is displayed), remove the batteries from all units for 1 minute and start the Setup procedure again at Step 1.

MOUNTING THE SENSORS AND PLACEMENT OF THE WIRELESS DISPLAY:

IMPORTANT: Ensure that all of the sensor data can be received at the intended mounting locations before you drill mounting holes. The wind and rain sensors have a wireless range of **200-feet** & the thermo-hygro sensor has a wireless range of **200-feet**. Keep in mind that the ranges equate to an open air scenario with no obstructions. Each obstruction (roof, walls, floors, ceilings, etc.) will reduce the range.

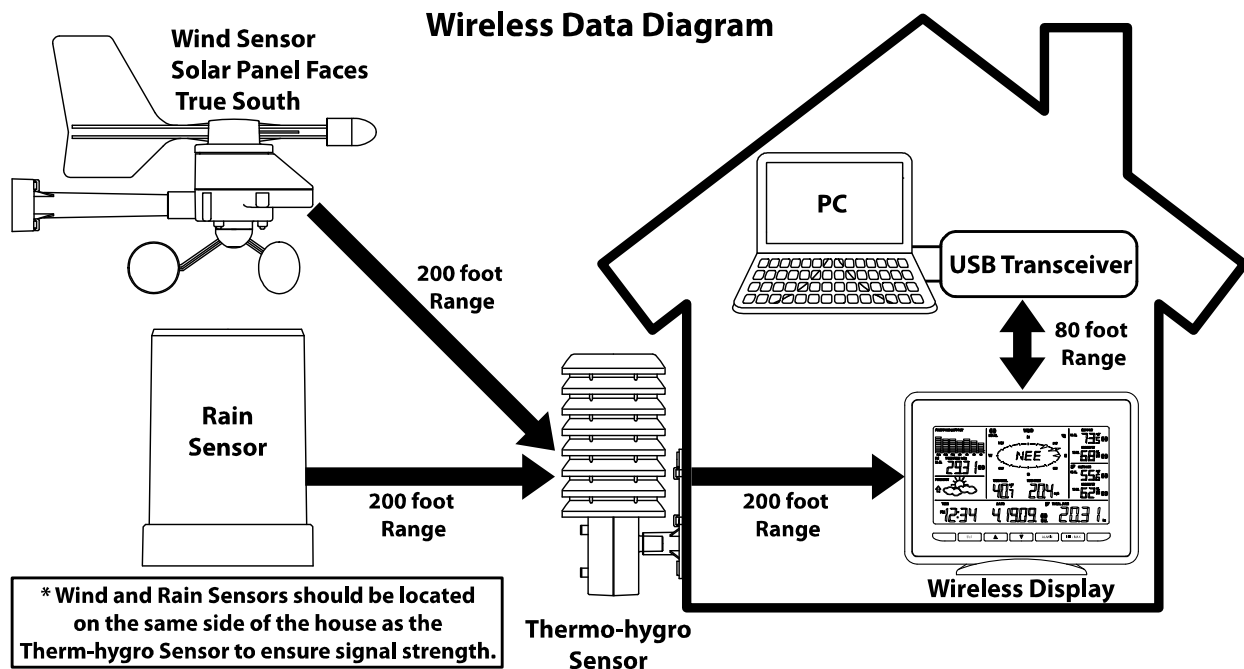

The thermo-hygro sensor measures outdoor temperature & humidity and collects the data from the wind and the rain sensors. It sends all outdoor weather data to the wireless display, so the thermo-hygro sensor must be within the **200-foot** wireless range of the wireless display. This allows the wind and rain sensors to be placed relative to the thermo-hygro sensor rather than the wireless display. See Wireless Data Diagram above.

- The wind and rain sensors must be mounted within the **200-foot** wireless range of the thermo-hygro sensor and on the same side of the house.
- The wireless display must be within the **80-foot** wireless range of the USB transceiver to send weather data to the PC.
- In addition, 915 MHz sensors transmit better at a **minimum mounted height of 6 feet**.

If the sensor wireless icons ☼ drop from the display as you move them into their intended locations, the sensors may be too far from the wireless display. Try moving the wireless display or the sensors closer and wait a few minutes to see if the wireless icons ☼ display again. If the wireless icons ☼ are still not displayed after re-positioning the sensors or the wireless display, press and hold the ▲ UP ARROW key for 2 seconds to re-synchronize the wireless display with the sensors.

WIND SENSOR

The wind sensor must be installed **with the front of the sensor (the solar panel) facing true South**, or the reported wind direction will not be accurate. Mount within the **200-foot** wireless range of the thermo-hygro sensor and on the same side of the house. The roof may or may not be an ideal mounting location. Secure the main unit to the shaft of the mast holder. Use the right-angle adaptor if the wind sensor will be mounted on a horizontal mast or surface.

Fasten the wind sensor to a suitable mast using the two U-bolts, washers and nuts included.

Note: Mount the wind sensor onto a mast, at a minimum height of 6 feet, so the wind can reach the sensor unobstructed from all directions for an accurate reading. The ideal mast is between 0.62" and 1.3" in diameter. The wind sensor DOES NOT have replaceable batteries; it consumes solar power and charges the internal battery pack automatically.



Note: Do not open the wind sensor. This will void the warranty.

RAIN SENSOR

The rain sensor should be mounted on a level surface in an open area within the **200-foot** wireless range of the thermo-hygro sensor and on the same side of the house. Mount the rain sensor at least 6 feet off the ground and level for optimum wireless transmission. The rain sensor should be accessible to allow for periodic cleaning of debris or insects.

THERMO-HYGRO SENSOR

The thermo-hygro sensor is "weather resistant", but not "water proof". To ensure an extended life for the sensor, mount it in a semi-covered place out of the elements at a minimum height of 6 feet. An ideal location for the thermo-hygro sensor is under the eaves on the North side of the house to avoid the effects of sunlight. Mount the sensor 18" down from the eaves to ensure optimum performance. This will assure the temperature of the air coming out of the attic will not affect data collected by the sensor.

To wall mount the thermo-hygro sensor, fix the wall holder onto the desired wall using the included screws, plug the sensor firmly into the wall holder and replace the rain cover if it is not already in place. **NOTE:** After mounting the units, if the weather data is not received, press and hold the ▲ UP ARROW key for 2 seconds to synchronize the wireless display to the sensors.

DISPLAY AND HEAVY WEATHER PC SOFTWARE

Position the display station to receive data from the thermo-hygro sensor and send data to the USBTRX-10, which plugs into the computer and downloads information to the Heavy Weather Pro PC software.

Read the **Release Notes** to verify the correct software version and download the free Heavy Weather Pro PC software at: <http://www.lacrossetechnology.com/support/software.php>

The **Software User's Guide** is found in the **?|Help** menu item in the software after installation.

FUNCTION KEYS:

SET KEY

- Press and hold for 3 seconds to enter the SET mode, where the following can be changed: LCD contrast, Manual time setting, 12/24 hour time display, Date setting, °F/°C temperature unit, Wind speed unit, Rainfall unit, Pressure unit, Relative pressure reference setting, Weather tendency threshold setting, Storm warning threshold setting, Storm Alarm On/ Off setting, Wind direction display type, and Factory reset
- Press to toggle between the display of Mode 1 or Mode 2:
 - **Mode 1:** "Wind speed + outdoor temp + 24 hr. pressure history graph"
 - **Mode 2:** "Gust + Dew Point temp + 72 hr. pressure history graph "
- In the weather alarm setting mode, press to switch the weather alarm On / Off
- In the weather alarm setting mode, press and hold to adjust the weather alarm value
- Stop the weather alarm when ringing

▲ UP ARROW KEY

- Press to toggle between the display of seconds or date in the time display
- Press to increase the level of different settings in SET mode
- Press and hold to re-learn the thermo-hygro sensor synchronization
- Press to reset the MIN/MAX record when in MIN/MAX display mode
- Stop the weather alarm when ringing

▼ DOWN ARROW KEY

- Press to switch the rainfall display mode: Total, 1h, 24h, week, month
- Press to decrease the level of different settings in SET mode
- Synchronize the display with the PC (see Heavy Weather Pro Software User's Guide)
- Stop the weather alarm when ringing

ALARM KEY

- Press to enter the time alarm and weather alarm setting mode
- Confirm particular alarm setting
- Press to exit the manual setting mode

- Stop the alarm when the time alarm or weather alarm rings
- Press to exit max/ min record display mode
- Stop the weather alarm when ringing

MIN/MAX KEY

- Press to display minimum and maximum records of various weather data
- Stop the weather alarm when ringing

MODE 1 DISPLAY:

- Press the SET key to toggle between Mode 1 and Mode 2 display:
- Pressure history graph displays 24 hour history
- Outdoor temperature displayed in the outdoor section
- Wind speed displayed in the wind section

MODE 2 DISPLAY:

- Press the SET key to toggle between Mode 1 and Mode 2 display:
- Pressure history graph displays 72 hour history
- Dew point displayed in the outdoor section
- Wind gust displayed in the wind section

DATE OR SECONDS DISPLAY MODE

- Press the ▲ UP ARROW key to toggle between display of the date or seconds

LCD SCREEN

When the signal from an outdoor transmitter is successfully received by the Weather Station, the corresponding ☼ icon will be switched on. (If not successful, the ☼ icon will not be shown on the LCD). The user can see whether the last reception was successful (☼ icon is on) or not (☼ icon is off). Blinking of the ☼ icon shows that a reception is in process.

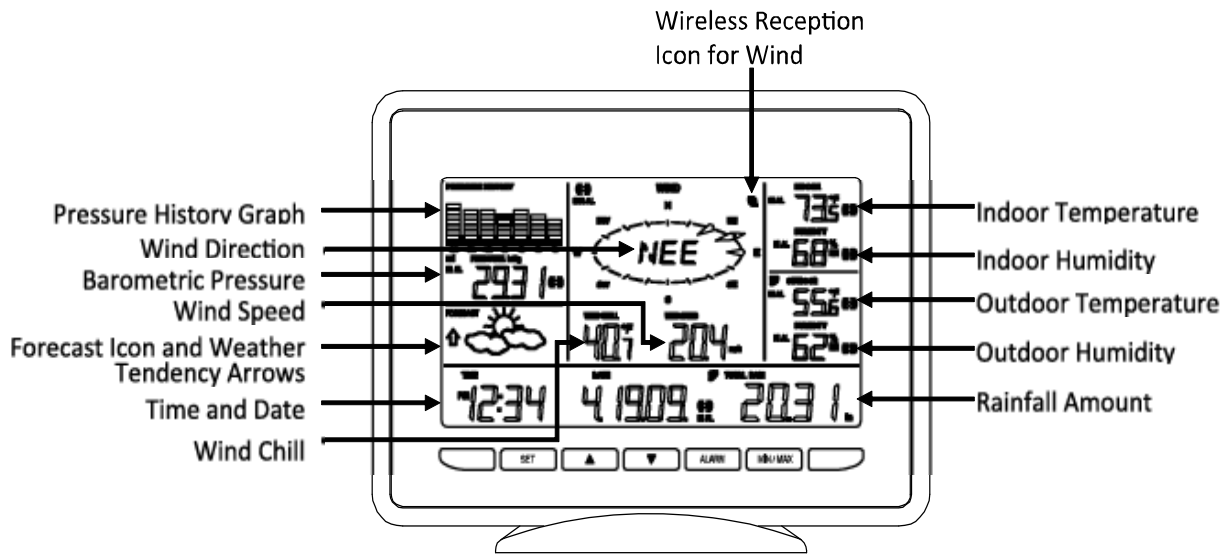

MANUAL SETTINGS:

Press and hold the SET key for 3 seconds to enter the SET mode. The display will automatically return to Mode 1 display in 30 seconds if a key is not pressed.

While in SET mode, each press of the SET key will advance to the next SET mode item:

1. LCD contrast setting
2. Manual time setting
3. 12/24 hour time display
4. Date setting
5. °F/°C temperature unit setting
6. Wind speed unit
7. Rainfall unit setting
8. Air pressure unit setting
9. Relative pressure reference value setting
10. Weather tendency threshold value
11. Storm warning threshold value
12. Alarm On/ Off setting
13. Wind direction display type
14. Factory Reset

LCD CONTRAST SETTING

The LCD contrast can be set within 8 levels, from "Lcd 1" to "Lcd 8" (default setting is "Lcd 5"):

1. Press and hold the SET key for 3 seconds; the contrast level digit will start flashing.
2. Press the ▲ UP ARROW key or ▼ DOWN ARROW key to adjust the level of contrast.
3. Press the SET key to confirm and to enter the **MANUAL TIME SETTING**.

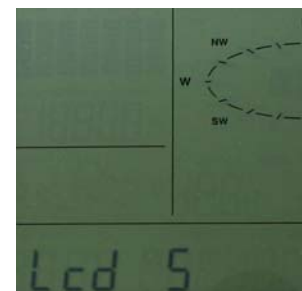

MANUAL TIME SETTING:

The time will be updated automatically with the time from the computer when the display is synchronized with the USB transceiver and connected to the Heavy Weather Pro software. The time can be set manually by following the steps below.

1. The hour digit will flash.
2. Press the ▲UP ARROW key or ▼DOWN ARROW key to set the hour.
3. Press the SET key to switch to the minutes. The minute digit will flash.
4. Press the ▲UP ARROW key or ▼DOWN ARROW key to set the minute.
5. Press the SET key to confirm and to enter the **12/24-HOUR TIME DISPLAY SETTING**.



12/24 HOUR TIME DISPLAY SETTING:

The time can be set as 12-hour or 24-hour format. To change the time display:

1. The "12h" or "24h" digits will flash.
2. Press the ▲UP ARROW key or ▼DOWN ARROW key to toggle the value.
3. Press the SET key to confirm and to enter the **DATE SETTING**.

DATE SETTING:

The default date is 1. 1. of the year 2009. The date will be updated automatically with the date from the computer when the display is synchronized with the USB transceiver and connected to the Heavy Weather Pro software. The date can also be set manually by following the steps below.

1. The year digit will flash.
2. Press the ▲UP ARROW key or ▼DOWN ARROW key to set the year. The range runs from "00" (2000) to "99" (2099).
3. Press the SET key to confirm the year and enter the month setting. The month digit will flash.
4. Press the ▲UP ARROW key or ▼DOWN ARROW key to set the month.
5. Press the SET key to confirm the month and enter the date setting mode. The date digit will flash.
6. Press the ▲UP ARROW key or ▼DOWN ARROW key to set the date.
7. Press the SET key to confirm and to enter the **°F/°C TEMPERATURE UNIT SETTING**.

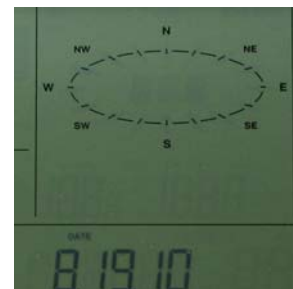

°F/°C TEMPERATURE UNIT SETTING

The temperature can be displayed in °F or °C. (default °F)

1. The temperature unit will flash.
2. Press the ▲UP ARROW key or ▼DOWN ARROW key to toggle between "°F" or "°C".



3. Press the SET key to confirm and to enter the **WIND SPEED UNIT SETTING**.

WIND SPEED UNIT SETTING

The wind speed unit can be set as mph (miles per hour), km/h (kilometers per hour), bft (Beaufort), knots, or m/s (meters per second). The default unit is mph.

1. Press the ▲UP ARROW key or ▼DOWN ARROW key to toggle between the unit “mph”, “km/h”, “bft”, “knots” or “m/s”
2. Press the SET key to confirm and to enter the **RAINFALL UNIT SETTING**.

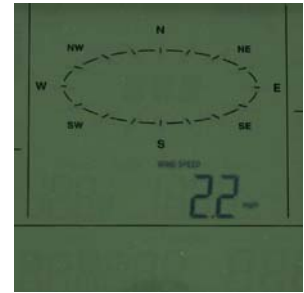

RAINFALL UNIT SETTING

The rainfall unit can be set as inch or mm. The default unit is inch.

1. Press the ▲UP ARROW key or ▼DOWN ARROW key to toggle between the unit “inch” or “mm”
2. Press the SET key to confirm and to enter the **RELATIVE AIR PRESSURE UNIT SETTING**

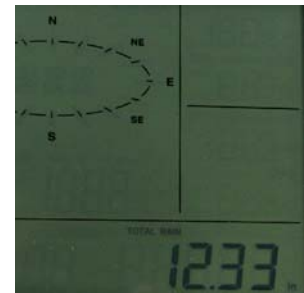

RELATIVE AIR PRESSURE UNIT SETTING

The relative air pressure can be set as inHg (inches of mercury) or hPa (hectopascal). The default unit is inHg.

1. Press the ▲UP ARROW key or ▼DOWN ARROW key to toggle between the unit “inHg” or “hPa”
2. Press the SET key to confirm and to enter the **RELATIVE PRESSURE REFERENCE VALUE SETTING**.

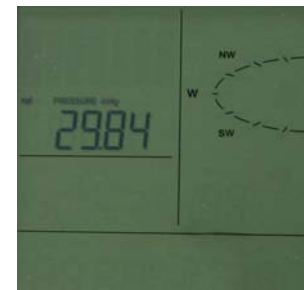

RELATIVE PRESSURE REFERENCE VALUE SETTING

 **Note:** For an exact measurement, it is necessary to adjust the barometer to the local relative air pressure (related to elevation above sea level). Ask for the current air pressure of the home area (local weather service, the world wide web, optician, calibrated instruments in public buildings, airport). The default reference pressure value is 29.91 inHg.

The relative air pressure can be manually set to another value within the range of 27.17 to 31.90 inHg (920 to 1080 hPa) for a better reference.

1. The current relative pressure value will flash.
2. Press the ▲UP ARROW key or ▼DOWN ARROW key to increase or decrease the value.

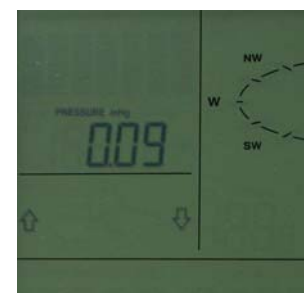

Continually holding the key will allow the value to increase faster.

3. Press the SET key to confirm and enter the **WEATHER TENDENCY SENSITIVITY SETTING**.

WEATHER TENDENCY SENSITIVITY SETTING

The sensitivity of the weather forecast icons to changes in air pressure can be set manually. Smaller values result in a more sensitive forecast. The switching sensitivity value can be set to .06, .09, or .12 inHg (2, 3 or 4 hPa). Select lower values (.06) for high humidity areas like the coastline. Select high numbers (.12) for dry areas like the desert. The default value is 0.09 inHg.

1. The sensitivity value will flash.
2. Press the ▲UP ARROW key or ▼DOWN ARROW key to select the value.
3. Press the SET key to confirm and to enter the **STORM WARNING SENSITIVITY SETTING**.

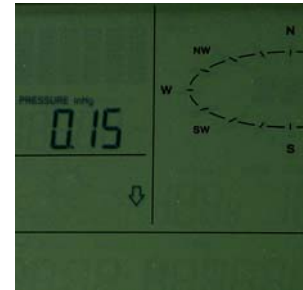

STORM WARNING THRESHOLD VALUE SETTING

A storm warning is displayed by flashing of the down weather tendency arrow when the air pressure decreases a specified amount over six hours. The sensitivity value for the storm warning display can be set between .09 inHg to .27 inHg (3hPa to 9hPa). The default value is 0.15 inHg.

1. The sensitivity value will flash.
2. Press the ▲UP ARROW key or ▼DOWN ARROW key to select the value.
3. Press the SET key to confirm and to enter the **STORM ALARM ON/OFF SETTING**.

STORM ALARM ON/ OFF SETTING

The storm warning display (flashing downward weather tendency arrow) can be accompanied by a ring of the alarm. Switch the acoustic storm warning alarm On (AON) or Off (AOFF) (Default OFF).

1. The digit "AOFF" will flash.
2. Press the ▲UP ARROW key or ▼DOWN ARROW key to switch the alarm On or Off. ("AOFF" = Off; "AON" = On)
3. Press the SET key to confirm and to enter the **WIND DIRECTION DISPLAY TYPE SETTING**.

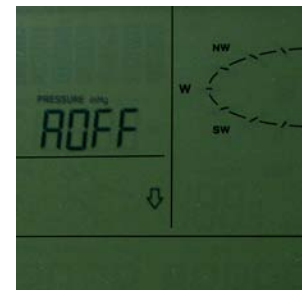

WIND DIRECTION DISPLAY TYPE SETTING

The wind direction can be displayed using either compass directions or degree measurements. N is equivalent to 0° on the compass. The default setting is compass directions.

1. The wind direction will flash.

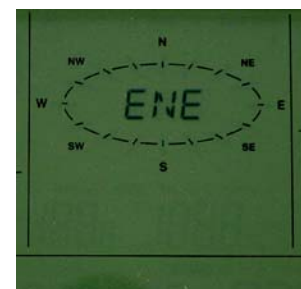

2. Press the ▲UP ARROW key or ▼DOWN ARROW key to toggle from compass directions to degree measurements.
3. The next step in the SET mode is the factory reset, so unless you wish to reset the display to factory defaults, simply wait until the SET mode times out and returns to the Mode 1 display.
4. If you wish to perform a FACTORY RESET, press the SET key to confirm and to enter the **FACTORY RESET PROCEDURE**. **SEE WARNINGS** in the FACTORY RESET section.

FACTORY RESET PROCEDURE



WARNING:

Performing a factory reset will erase all MIN/MAX values and weather data stored in the display's internal memory and return the weather units settings back to the factory defaults. If you have not yet uploaded the data to the Heavy Weather Pro software, the data will be lost. If you do not wish to reset the display to factory defaults, either:

- Press the MIN/MAX key or the ALARM key to exit SET mode, or
- Simply wait 30 seconds until the SET mode times out and returns to the Mode 1 display.

To reset the display to the factory defaults, follow the procedure below.



WARNING:

A **factory reset** will erase the connection between the display and the thermo-hygro sensor and require the all sensor connections to be re-established.

1. "rES OFF" will flash.
2. Use the ▲UP ARROW key or ▼DOWN ARROW key to select "rES on".
3. Press the SET key to confirm and a countdown timer will begin counting down from "127". When the timer displays "dOnE", you must remove the batteries from the display for 10 minutes. While the batteries are out of the display, also remove the batteries from the thermo-hygro sensor and rain sensor.
4. After waiting for 10 minutes, insert the batteries into the thermo-hygro sensor, and rain sensor making sure to align the "+" symbol on the batteries with the markings on the battery cover and inside the battery compartment.
5. Within 2 minutes of inserting the batteries into the sensors, insert the batteries into the display, making sure to align the "+" symbol on the batteries with the markings inside the battery compartment.
6. Wait 5 minutes for the outdoor weather data to display. If any of the outdoor data displays "--" after waiting for 5 minutes, follow the "Setting Up" Procedure near the beginning of this manual or in the Quick Set Up Manual included with the product.

TO EXIT THE MANUAL SETTING MODE

To exit the manual setting at any time, either:

- Press the MIN/MAX key or the ALARM key to exit SET mode, or
- Simply wait 30 seconds until the SET mode times out and returns to the Mode 1 display.

WEATHER ALARM OPERATIONS

The Weather alarms can be set when certain weather conditions are met according to the requirements. For example, you can set the thresholds for the outdoor temperature to +104°F (high) and 14°F (low), while enabling the high alarm and disabling the low alarm (i.e. temperatures <14°F won't trigger alarm, but temperatures >+104°F will).

- If the value meets the condition for high alarm or low alarm, the alarm will ring for 2 minutes and the value will blink, along with the corresponding icon ("HI AL"/ "LO AL").
- Press any key to stop a ringing alarm.
- The high and low alarms can be switched On/Off independently, according to the needs.
- If at any time during the alarm setting process you would like to exit alarm setting mode, press the MIN/MAX key or wait for about 30 seconds and the display will return to normal display mode automatically.
- Press the ALARM key to enter ALARM mode. Subsequent presses of the ALARM key will advance to the next weather alarm section.

 **Note:** Weather alarms can also be set from the Heavy Weather Pro software. Consult the Heavy Weather Pro Software User's Guide for instructions.

THE FOLLOWING WEATHER ALARMS CAN BE ADJUSTED IN ALARM SETTING MODE:

- High and Low pressure alarms
- High and Low indoor temperature alarms
- High and Low indoor humidity alarms
- High and Low outdoor temperature alarms
- High and Low outdoor humidity alarms
- High wind gust alarm
- Wind direction alarm
- Rainfall amount in 24 hour period alarm

DEFAULT WEATHER ALARM VALUES:

Pressure	Low	28.35 inHg
	High	30.71 inHg
Temperature (In or Out)	Low	32°F
	High	104°F
Relative Humidity (In or Out)	Low	45%
	High	70%

Wind gust	High	62.0mph
Wind Direction	North	
Rainfall in 24 hours	High	1.96 in

PRESSURE ALARMS

1. In the normal display mode, press the ALARM key once. The high-pressure alarm display will be shown.
2. Press and hold the SET key for about 2 seconds. The pressure digit will flash.
3. Press the ▲UP ARROW key or ▼DOWN ARROW key to set the high-pressure alarm value. Hold the arrow key in to change the value faster.
4. Press the ALARM key to confirm the setting. The digit will stop flashing.
5. Press the SET key to switch the alarm on or off. The (((•))) icon indicates the alarm is switched on.
6. Press the ALARM key once. The Low Pressure alarm display will be shown.
7. Press and hold the SET key for about 2 seconds. The pressure digit will flash.
8. Press the ▲UP ARROW key or ▼DOWN ARROW key to set the low-pressure alarm value. Hold the arrow key in to change the value faster.
9. Press the ALARM key to confirm the setting. The digit will stop flashing.
10. Press the SET key to switch the alarm on or off. The (((•))) icon indicates the alarm is switched on.
11. Press the ALARM key to move to the indoor temperature alarm settings.

INDOOR TEMPERATURE ALARMS

1. The high indoor temperature alarm display will be shown.
2. Press and hold the SET key for about 2 seconds. The temperature digit will flash.
3. Press the ▲UP ARROW key or ▼DOWN ARROW key to set the high indoor temperature alarm value. Hold the key in to change the value faster.
4. Press the ALARM key to confirm the setting. The digit will stop flashing.
5. Press the SET key to switch the alarm on or off. The (((•))) icon indicates that the alarm is switched on.
6. Press the ALARM key once. The low outdoor temperature alarm display will be shown.
7. Press and hold the SET key for about 2 seconds. The temperature digit will flash.
8. Press the ▲UP ARROW key or ▼DOWN ARROW key to set the low indoor temp alarm value. Hold the arrow key in to change the value faster.
9. Press the ALARM key to confirm the setting. The digit will flash.
10. Press the SET key to switch the alarm on or off. The (((•))) icon indicates the alarm is switched on.
11. Press the ALARM key to move to the indoor humidity alarm settings.

INDOOR HUMIDITY ALARMS

1. The high indoor humidity alarm display will be shown.
2. Press and hold the SET key for about 2 seconds. The humidity digit will flash.
3. Press the ▲UP ARROW key or ▼DOWN ARROW key to set the high indoor humidity alarm value.

4. Press the ALARM key to confirm the setting. The digit will stop flashing.
5. Press the SET key to switch the alarm on or off. The (((•))) icon indicates the alarm is switched on.
6. Press the ALARM key once. The low indoor humidity alarm display will be shown.
7. Press and hold the SET key for about 2 seconds. The humidity digit will flash.
8. Press the ▲UP ARROW key or ▼DOWN ARROW key to set the low indoor humidity alarm value.
9. Press the ALARM key to confirm the setting. The digit will stop flashing.
10. Press the SET key to switch the alarm on or off. The (((•))) icon indicates the alarm is switched on.
11. Press the ALARM key to move to the outdoor temperature alarm settings.

OUTDOOR TEMPERATURE ALARMS

1. The high outdoor temperature alarm display will be shown.
2. Press and hold the SET key for about 2 seconds. The temperature digit will flash.
3. Press the ▲UP ARROW key or ▼DOWN ARROW key to set the high outdoor temp alarm value. Hold the key in to change the value faster.
4. Press the ALARM key to confirm the setting. The digit will stop flashing.
5. Press the SET key to switch the alarm on or off. The (((•))) icon indicates that the alarm is switched on.
6. Press the ALARM key once. The low outdoor temperature alarm display will be shown.
7. Press and hold the SET key for about 2 seconds. The temperature digit will flash.
8. Press the ▲UP ARROW key or ▼DOWN ARROW key to set the low outdoor temp alarm value. Hold the arrow key in to change the value faster.
9. Press the ALARM key to confirm the setting. The digit will flash.
10. Press the SET key to switch the alarm on or off. The (((•))) icon indicates the alarm is switched on.
11. Press the ALARM key to move to the outdoor humidity alarm settings.

OUTDOOR HUMIDITY ALARMS

1. The high outdoor humidity alarm display will be shown.
2. Press and hold the SET key for about 2 seconds. The humidity digit will flash.
3. Press the ▲UP ARROW key or ▼DOWN ARROW key to set the high outdoor humidity alarm value.
4. Press the ALARM key to confirm the setting. The digit will stop flashing.
5. Press the SET key to switch the alarm on or off. The (((•))) icon indicates the alarm is switched on.
6. Press the ALARM key once. The low outdoor humidity alarm display will be shown.
7. Press and hold the SET key for about 2 seconds. The humidity digit will flash.
8. Press the ▲UP ARROW key or ▼DOWN ARROW key to set the low outdoor humidity alarm value.
9. Press the ALARM key to confirm the setting. The digit will stop flashing.

10. Press the SET key to switch the alarm on or off. The (((•))) icon indicates the alarm is switched on.
11. Press the ALARM key to move to the outdoor temperature alarm settings.

WIND GUST ALARM

1. The wind gust alarm display will be shown.
2. Press and hold the SET key for about 2 seconds. The wind gust digit will flash.
3. Press the ▲UP ARROW key or ▼DOWN ARROW key to set the wind gust alarm value.
4. Press the ALARM key to confirm the setting. The digit will stop flashing.
5. Press the SET key to switch on or off the alarm. The (((•))) icon indicates the alarm is switched on.
6. Press the ALARM key to move to the wind direction alarm settings.

WIND DIRECTION ALARM

Multiple wind direction alarms can be set simultaneously if desired.

1. The wind direction alarm display will be shown.
2. Press and hold the SET key for about 2 seconds. The wind direction arrow on the outside of the compass circle will flash with the corresponding compass direction or degrees reading displayed in the center of the compass.
3. Press the ▲UP ARROW key or ▼DOWN ARROW key to move the wind direction alarm pointer.
4. Press the SET key to set a wind direction alarm value. A pointer icon will appear inside of the compass circle to indicate an alarm setting for that wind direction.
5. To remove an alarm setting for a wind direction, press the SET key again to remove the selected wind direction alarm. The arrow icon inside the compass circle will disappear.
6. If more than one wind direction is desired as an alarm setting, Press the ▲UP ARROW key or ▼DOWN ARROW key to move the wind direction alarm pointer to the next desired setting.
7. Press the SET key to confirm the next wind direction value. A pointer icon will appear inside of the compass circle to indicate an alarm setting for that wind direction. You can set as many wind direction alarms as you desire.
8. Press the ALARM key to confirm the setting. The digit will stop flashing.
9. Press the SET key to switch on or off the alarm. The (((•))) icon indicates the alarm is switched on.
10. Press the ALARM key to move to the 24-hour rainfall alarm settings.

24 HOUR RAINFALL ALARM

1. The 24-hour rainfall alarm display will be shown.
2. Press and hold the SET key for about 2 seconds. The 24-hour rainfall digit will flash.
3. Press the ▲UP ARROW key or ▼DOWN ARROW key to set the 24-hour rainfall alarm value.

4. Press the ALARM key to confirm the setting. The digit will stop flashing.
5. Press the SET key to switch on or off the alarm. The ((•)) icon indicates the alarm is switched on.
6. Press the ALARM key to exit the alarm setting mode.

HYSTERESIS

To compensate for fluctuation of the weather data, which may cause the weather alarm to ring constantly if the measured reading is close to the alarm level, a hysteresis function has been implemented for each weather alarm.

For example, if the high temperature alarm is set to 77°F and the temperature reaches 77°F, the alarm will be activated. If the temperature then drops to 76.8°F (a change of less than 1.8°F) and then increases to 77°F again, the data will blink, but no alarm will be activated.



The temperature would have to drop below 75.2°F (with a pre-set hysteresis of 1.8°F) so that the alarm can be produced again. Hysteresis values for the various weather data types are given in the table.

Weather data	Hysteresis
Temperature	1.8°F
Humidity	3% RH
Pressure	0.029 inHg
Wind speed	6.2 mph

 **Note:** The temperature or humidity data will keep flashing even after a weather alarm has been switched off by a key press. The flashing value indicates that the current weather condition is out of the pre-set weather alarm limit(s).

WEATHER FORECAST AND WEATHER TENDENCY

WEATHER FORECASTING ICONS:

		
Sunny	Cloudy with sunny intervals	Rainy

For every sudden or significant change in the air pressure, the weather icons will update accordingly to represent the change in weather.

Every time a new average pressure value has been obtained (once per minute), this value is compared with an internal reference value. If the difference between these values is bigger than the selected weather tendency sensitivity, the weather-icon changes, either for worse or for better. In this case, the current pressure value becomes the new weather tendency reference.

If the icons do not change, either the air pressure has not changed or the change has been too small for the Weather Center to register. You may adjust the "sensitivity" of the pressure change check in the setting mode –see **WEATHER TENDENCY SENSITIVITY VALUE SETTING** above.

If the icon displayed is a sun or raining cloud, there will be no change of icon if the weather gets any better (with sunny icon) or worse (with rainy icon) since the icons are already at their extremes.

The displayed icon forecasts the weather in terms of getting better or worse and not necessarily sunny or rainy as each icon indicates. For example, if the current weather is cloudy and the rainy icon is displayed, it does not mean that the product is faulty because it is not raining. It simply means that the air pressure has dropped and the weather is expected to get worse but not necessarily rainy.

 **Note:** After set up, readings for weather forecasts should be disregarded for the next 48-60 hours. This will allow sufficient time for the Weather station to collect air pressure data at a constant altitude and therefore result in a more accurate forecast.

Common to weather forecasting, absolute accuracy cannot be guaranteed. The weather forecasting feature is estimated to have an accuracy level of about 75% due to the varying areas the Weather Center has been designed for use. 75% accuracy is comparable to the best meteorological forecasting rate. In areas that experience sudden changes in weather (for example from sunny to rain), the Weather Center will be more accurate compared to use in areas where the weather is stable most of the time (for example mostly sunny).

If the Weather Center is moved to another location significantly higher or lower than its initial standing point (for example from the ground floor to the upper floors of a house), discard the weather forecast for the next 48-60 hours, as the Weather Center may mistake the new location as being a possible change in air-pressure when really it is due to the slight change of altitude.

WEATHER TENDENCY INDICATOR

Working together with the weather icons is the weather tendency indicators (**arrows located on the left and right sides** of the weather icons). When the indicator points upwards, it means that the air-pressure is increasing and the weather is expected to improve, but when the indicator points downwards, the air-pressure is dropping and the weather is expected to become worse.

Taking this into account, one can see how the weather has changed and is expected to change. For example, if the indicator is pointing downwards together with cloud and sun icons, then the last noticeable change in the weather was when it was sunny (the sun icon only). Therefore, the next change in the weather will be cloud with rain icons since the indicator is pointing downwards.

 **Note:** Once the weather tendency indicator has registered a change in air pressure, either the upward or downward tendency arrow will be displayed until the tendency changes again.

AIR PRESSURE HISTORY GRAPH

The LCD shows the relative air pressure value and the air pressure history on a bar graph. Press the SET key to toggle between Mode1 and Mode2 of the display.

Mode 1: The bar graph displays the air pressure history of the past 24 hours in seven steps. The horizontal axis represents the last 24 hours of air pressure recording (-24, -18, -12, -8, -6, -3 and 0 hour).

Mode 2: The bar graph displays the air pressure history of the past 72 hours in seven steps. The horizontal axis represents the last 72 hours of air pressure recording (-72, -48, -36, -24, -12, -6 and 0 hour).

The vertical bars are plotted at each of the seven steps and give the trend over the recorded period. The 0 hour vertical bar will always display at the midline height to indicate the current air pressure. The varying height of bars in other columns on the graph indicate a relative change in air pressure up or down from the previous measurement.

New pressure measurements are compared to previously recorded pressure measurements. The pressure change is expressed by the difference between the current ("0h") and the past readings in divisions of ± 0.06 inHg or ± 2 hPa. If the bars are rising from left to right, this indicates that the weather is getting better due to an increase in air pressure. If the bars are falling from left to right, this indicates that the weather is expected to get worse due to a drop in air pressure.

At every full hour, the current air pressure is used as a basis for the display of a new graph bar. The existing graph is then moved one column to the left.

 **Note:** For accurate barometric pressure trend, the Weather Center should operate at the same altitude. Should the unit be moved, for instance from the ground to the second floor of the house, the readings for the next 48-60 hours shall be discarded.

 **Note:** The bar graph will scroll right to left regularly to prevent LCD burnout.

WIND DIRECTION AND WIND SPEED MEASUREMENT

- A pointer on the outer circle of the compass indicates the current wind direction.
- The last 6 wind directions are displayed with pointers on the inner circle.
- The wind direction (abbreviation or degrees) is displayed in center of compass.

Press the SET key to toggle between Mode1 and Mode 2 of the display.

Mode 1 displays the following wind data:

- Wind direction
- Wind chill in $^{\circ}\text{F}$ or $^{\circ}\text{C}$
- Wind **speed** in mph, km/h, bft, knots or m/s

Mode 2 displays the following wind data:

- Wind direction
- Wind chill in °F or °C
- Wind **gust** in mph, km/h, bft, knots or m/s

RAINFALL MEASUREMENT

The 1hour, 24-hour, week, month or total rainfall measurement is displayed on the LCD, in the unit of inch or mm.

- Press the ▼DOWN ARROW to select the rainfall display from the following modes:
 1. Total rainfall - reset manually (see "RESET THE MIN/MAX WEATHER DATA")
 2. Last 1 hour rainfall – updates every four minutes, totals last 15 measurements
 3. Last 24 hours rainfall from current time.
 4. Last week rainfall - reset every Monday night at 12:00am (midnight)
 5. Last month rainfall - reset every 1st of month at 12:00am (midnight)

VIEWING THE MIN/MAX WEATHER DATA

The weather station will record the maximum and minimum value of the various weather data with time and date of recording automatically. The following stored maximum and minimum weather data can be viewed by pressing the MIN/MAX key in normal display mode.

1. MIN/MAX indoor temperature with the date and time of recording
2. MIN/MAX indoor humidity with the date and time of recording
3. MIN/MAX outdoor temperature with the date and time of recording
4. MIN/MAX dew point temperature with the date and time of recording
5. MIN/MAX outdoor humidity with the date and time of recording
6. MAX wind gust with the date and time of recording
7. Total rainfall with the date the rainfall total was last reset. If the rainfall total has not yet been reset, "---. --. ---- will be displayed for the date.

RESET THE MIN/MAX WEATHER DATA

1. Press MIN/MAX key to show the desired weather data.
2. Press ▲UP ARROW key. The stored value will be reset to the current value and current time. To reset the MIN/MAX weather data, you need to reset each of the values independently.

TOTAL RAINFALL AMOUNT

The total rainfall measurement is displayed in the unit of mm or inch. It shows the total rainfall accumulated since last reset of the total rainfall amount.

In either Mode 1 or Mode 2 display, press the MIN/MAX key until the display shows the total rainfall value.

To reset the rainfall reading, press the ▲ UP ARROW key. The total rainfall amount will be reset to 0, and the time is updated to current time.

 **Note:** Until the first rainfall total reset is performed, the time and date of the total rainfall are displayed as "- - -.-.----". After the rainfall total is reset, the rainfall total display will indicate the date and time of the last rainfall total reset.

CARE AND MAINTENANCE:

- Extreme temperatures, vibration and shock should be avoided as these may cause damage to the unit and give inaccurate forecasts and readings.
- Precautions shall be taken when handling the batteries. Injuries, burns, or property damage may be resulted if the batteries are in contact with conducting materials, heat, corrosive materials or explosives. The batteries shall be taken out from the unit before the product is to be stored for a long period of time.
- Immediately remove all low powered batteries to avoid leakage and damage. Replace only with new batteries of the recommended type.
- When cleaning the display and casings, use a soft damp cloth only. Do not use solvents or scouring agents as they may mark the LCD and casings.
- Do not submerge the unit in water.
- Special care shall be taken when handling a damaged LCD display. The liquid crystals can be harmful to user's health.
- Do not make any repair attempts to the unit. Return them to their original point of purchase for repair by a qualified engineer. Opening and tampering with the unit may invalidate their guarantee.
- Never touch the exposed electronic circuit of the device as there is a danger of electric shock should it become exposed.
- Do not expose the display to extreme and sudden temperature changes, this may lead to rapid changes in forecasts and readings and thereby reduce their accuracy.

SPECIFICATIONS:

INDOOR TEMPERATURE

-40°F to +139.8°F with 0.2°F resolution
-9.9°C to +59.9°C with 0.1°C resolution
(“OF.L” displayed if outside this range)

INDOOR HUMIDITY

1% to 99% with 1% resolution
(“- -” displayed if < 1%, “99” displayed if ≥ 99%)

OUTDOOR TEMPERATURE / DEW POINT

-40°F to +139.8°F with 0.2°F resolution
-9.9°C to +59.9°C with 0.1°C resolution
("OF.L" displayed if outside this range)

OUTDOOR HUMIDITY

1% to 99% with 1% resolution
("- -" displayed if < 1%, "99" displayed if ≥ 99%)

WIND SPEED/ GUST

0 to 111.8 mph with resolution of 0.22 mph
0 to 180 km/h with resolution of 0.36 km/h
0 to 12 bft
0 to 97.1 knots with resolution of 0.19 knots
0 to 50 m/s with resolution of 0.1 m/s
(displays "OF.L" when > 111.62 mph; 49.9 m/s)

WIND CHILL

-40°F to +139.8°F with 0.2°F resolution
-40°C to +59.9°C with 0.1°C resolution
(displays "OF.L" if outside this)

RAINFALL

0" to 393.7" with 0.01 inch resolution
0 to 9999 mm with 0.1 mm resolution
(displays "OF.L" when > 393.7")

OUTDOOR DATA RECEPTION

Temperature and humidity data every 13 seconds

Wind data every 17 seconds

Rain data every 19 seconds

AIR PRESSURE

8.86 inHg to 32.46 inHg

300 hPa to 1099 hPa

Relative pressure pre-set range: 27.17 to 31.90 inHg (919 to 1080 hPa)

measured every 15 seconds

TRANSMISSION RANGE

Thermo-hygro: 200 feet in open space

Rain: 200 feet in open space

Wind: 200 feet in open space

POWER CONSUMPTION

WEATHER CENTER

3 x C size batteries (IEC LR14, 1.5V)

THERMO-HYGRO TRANSMITTER

2 x C size batteries (IEC LR14, 1.5V)

RAIN SENSOR

2 x AA size batteries (IEC LR6, 1.5V)

WIND SENSOR

Solar powered

BATTERY LIFE

Approximately 24 months (Alkaline batteries recommended)

- The electrical and electronic wastes contain hazardous substances. Disposal of electronic waste in wild country and/or in unauthorized grounds strongly damages the environment.
- Please contact the local or/and regional authorities to retrieve the addresses of legal dumping grounds with selective collection.
- All electronic instruments must from now on be recycled. User shall take an active part in the reuse, recycling and recovery of the electrical and electronic waste.
- The unrestricted disposal of electronic waste may do harm on public health and the quality of environment.
- As stated on the gift box and labeled on the product, reading the “User manual” is highly recommended for the benefit of the user. This product should not be thrown in general rubbish collection points.
- The manufacturer and supplier cannot accept any responsibility for any incorrect readings and any consequences that occur should an inaccurate reading take place.
- This product is designed for use in the home only as indication of the temperature.
- This product is not to be used for medical purposes or for public information.
- The specifications of this product may change without prior notice.
- This product is not a toy. Keep out of the reach of children.
- No part of this manual may be reproduced without written authorization of the manufacturer.

Statement according to FCC part 15.19:

This device complies with part 15 of the FCC rules. Operation is subject to the following two conditions:

- (1) This device may not cause harmful interference.
- (2) This device must accept any interference received, including interference that may cause undesired operation.

Statement according to FCC part 15.21:

Modifications not expressly approved by this company could void the user's authority to operate the equipment.

Statement according to FCC part 15.105:

NOTE: This equipment has been tested and found to comply with the limits for a Class B digital device, pursuant to Part 15 of the FCC Rules. These limits are designed to provide reasonable protection against harmful interference in a residential installation. This equipment generates, uses and can radiate radio frequency energy and, if not installed and used in accordance with the instructions, may cause harmful interference to radio communications.

However, there is no guarantee that interference will not occur in a particular installation. If this equipment does cause harmful interference to radio or television reception, which can be determined by turning the equipment off and on, the user is encouraged to try to correct the interference by one or more of the following measures:

- Reorient or relocate the receiving antenna.
- Increase the separation between the equipment and receiver.
- Connect the equipment into an outlet on a circuit different from that to which the receiver is connected.
- Consult the dealer or an experienced radio/TV technician for help.

WARRANTY INFORMATION

La Crosse Technology, Ltd provides a 1-year limited warranty on this product against manufacturing defects in materials and workmanship.

This limited warranty begins on the original date of purchase, is valid only on products purchased and used in North America and only to the original purchaser of this product. To receive warranty service, the purchaser must contact La Crosse Technology, Ltd for problem determination and service procedures. Warranty service can only be performed by a La Crosse Technology, Ltd authorized service center. The original dated bill of sale must be presented upon request as proof of purchase to La Crosse Technology, Ltd or La Crosse Technology, Ltd's authorized service center.

La Crosse Technology, Ltd will repair or replace this product, at our option and at no charge as stipulated herein, with new or reconditioned parts or products if found to be defective during the limited warranty period specified above. All replaced parts and products become the property of La Crosse Technology, Ltd and must be returned to La Crosse Technology, Ltd. Replacement parts and products assume the remaining original warranty, or ninety (90) days, whichever is longer. La Crosse Technology, Ltd will pay all expenses for labor and materials for all repairs covered by this warranty. If necessary repairs are not covered by this warranty, or if a product is examined which is not in need or repair, you will be charged for the repairs or examination. The owner must pay any shipping charges incurred in getting the La Crosse Technology, Ltd product to a La Crosse Technology, Ltd authorized service center. La Crosse Technology, Ltd will pay ground return shipping charges to the owner of the product to a USA address only.

The La Crosse Technology, Ltd warranty covers all defects in material and workmanship with the following specified exceptions: (1) damage caused by accident, unreasonable use or neglect (including the lack of reasonable and necessary maintenance); (2) damage occurring during shipment (claims must be presented to the carrier); (3) damage to, or deterioration of, any accessory or decorative surface; (4) damage resulting from failure to follow instructions contained in the owner's manual; (5) damage resulting from the performance of repairs or alterations by someone other than an authorized La Crosse Technology, Ltd authorized service center; (6) units used for other than home use (7) applications and uses that this product was not intended or (8) the products inability to receive a signal due to any source of interference.. This warranty covers only actual defects within the product itself, and does not cover the cost of installation or removal from a fixed installation, normal set-up or adjustments, claims based on misrepresentation by the seller or performance variations resulting from installation-related circumstances.

LA CROSSE TECHNOLOGY, LTD WILL NOT ASSUME LIABILITY FOR INCIDENTAL, CONSEQUENTIAL, PUNITIVE, OR OTHER SIMILAR DAMAGES ASSOCIATED WITH THE OPERATION OR MALFUNCTION OF THIS PRODUCT. THIS PRODUCT IS NOT TO BE USED FOR MEDICAL PURPOSES OR FOR PUBLIC INFORMATION. THIS PRODUCT IS NOT A TOY. KEEP OUT OF CHILDREN'S REACH.

This warranty gives you specific legal rights. You may also have other rights specific to the State. Some States do not allow the exclusion of consequential or incidental damages therefore the above exclusion of limitation may not apply to you.

For warranty work, technical support, or information contact:

La Crosse Technology, Ltd
2817 Losey Blvd. S.
La Crosse, WI 54601

Customer Support: www.lacrosstechnology.com/support

For more information: www.lacrosstechnology.com/2810