

LA CROSSE®  
TECHNOLOGY

# WEATHER STATION WITH FORECAST AND ATOMIC TIME

## INSTRUCTION MANUAL



MODELS: 308-1417BLV2  
DC: 112318

FIND MANUALS, FAQs, AND MORE UNDER THE  
SUPPORT TAB HERE: [bit.ly/308-1417blv2](http://bit.ly/308-1417blv2)

# TABLE OF CONTENTS

- [3. Power Up](#)
- [3. Settings Menu](#)
- [5. WWVB Atomic Time Signal](#)
- [5. Adjustable Backlight](#)
- [5. Pressure History Graph & Number](#)
- [6. Weather Forecast Icons](#)
- [6. HI/LO Temperature & Humidity Alerts](#)
- [7. Temperature & Humidity Alerts](#)
- [8. Temperature & Humidity Trend Arrows](#)
- [8. Sensor Search](#)
- [9. Change Batteries](#)
- [9. Factory Restart](#)
- [9. Sensor Weather Shield](#)
- [10. We're Here to Help!](#)
- [10. Join the Conversation](#)
- [10. Care and Maintenance](#)
- [11. Specifications](#)
- [11. Warranty Info](#)
- [12. FCC Statement](#)

## POWER UP

1. Insert 2-AA batteries into your Outdoor Sensor.
2. Insert the 5 volt power cord into an outlet, then into your Weather Station. Optional: Insert 3-AA batteries for backup.
3. Adjust time and date settings on each display.
4. Once the Outdoor Sensor is reading to each of your displays, place it outside in a shaded location.

Watch sensor mounting video: [http://bit.ly/TH\\_SensorMounting](http://bit.ly/TH_SensorMounting)

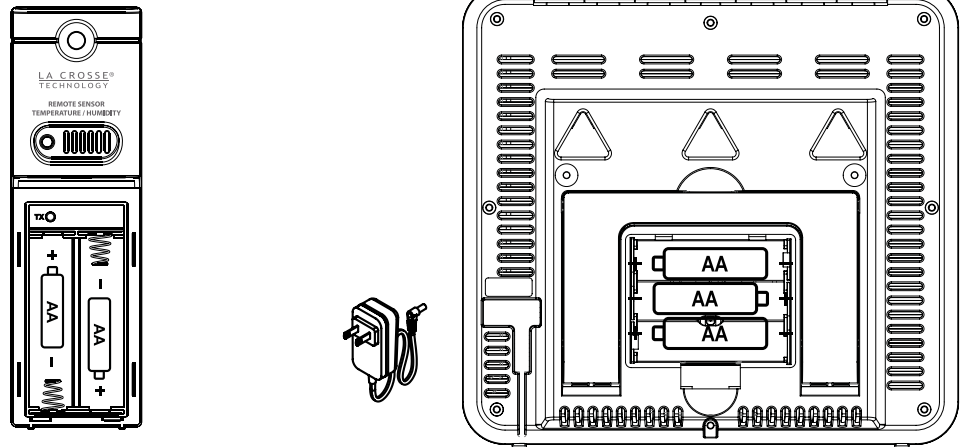

## SETTINGS MENU

1. Hold the SET button to enter the Settings Menu.
2. Use the + or - button to adjust and SET to confirm.
3. Press the SEACH button at anytime to exit the Settings Menu.

### Settings Menu order:

- Language: (English, Español, Français)
- Beep ON | OFF
- Atomic ON | OFF
- DST ON | OFF (Daylight Saving Time)
- Time Zone
- 12Hr | 24Hr Format
- Hour
- Minutes
- Year
- Month
- Date
- Temperature Fahrenheit | Celsius
- Pressure units: INHG or HPA
- Pressure number setting

### Time Zones

ATLANTIC  
EASTERN  
CENTRAL  
MOUNTAIN  
PACIFIC  
ALASKA  
HAWAII

**Note:** When Español or Français is selected, the following instructions and weekday will be presented in that language.

**Note:** Weekday sets automatically when Year, Month and Date are set.

**Language**

ENGLISH	

**Beep ON | OFF**

ON BEEP	

**Atomic ON | OFF**

ON ATOMIC	

**DST ON | OFF**

ON DST	

**Time Zone**

AM 12:00 EASTERN	

**12Hr | 24Hr**

24 FORMAT	

**Set Hour**

AM 12 SET HOUR	

**Minutes**

:34 MINUTES	

**Set Year**

20 17 SET YEAR	

**Set Month**

JAN SET MONTH	

**Set Date**

/01 SET DATE	

**Temp °F | °C**

OF TEMP	

**Pressure: INHG | HPA**

RELATIVE PRESSURE 29.31 inHg	
INHG PRESSURE	

**Pressure Number**

RELATIVE PRESSURE 30.02 inHg	
PRESSURE	

## WWVB ATOMIC TIME SIGNAL

- The station will automatically search for the atomic time signal at UTC 7:00, 8:00, 9:00, 10:00, and 11:00.
- The Atomic Time Signal Icon  will flash while searching, and be solid when connected.
- Press the SEARCH button anytime, to manually search for the atomic time signal.
- For information about WWVB visit: <http://bit.ly/AtomicTime>

## ADJUSTABLE BACKLIGHT

- Press and release the LIGHT button to adjust the White Backlight; HI-LOW-OFF.
- When operating on batteries only, press the LIGHT button for a 10 second backlight.

## PRESSURE HISTORY GRAPH & NUMBER

Read from left to right, the Pressure History Graph indicates the rise and fall in air pressure over the past 24 hours.

- The “0h” indicates the current hour, thus the current air pressure also.
- At every full hour the current air pressure is used as a basis for the display of a new graph bar.
- Air pressure trends can be determined by simply glancing at the bar graph.
  - A. If the bars are rising (higher on the right than the left) then the air pressure has a rising trend, and the weather should improve.
  - B. If the bars are dropping (lower on the right than the left) then the air pressure has a falling trend, and the weather should worsen.
- The bar chart will constantly scroll to provide visual interest. This cannot be turned off.

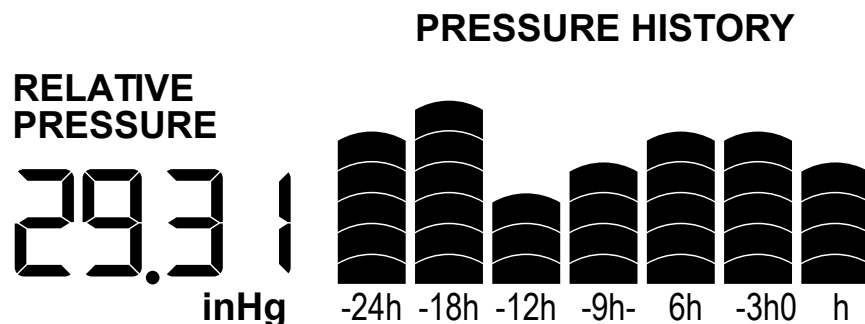

- The Relative Pressure numbers represent the current Barometric Pressure reading from the pressure sensor inside the weather station.
- This number can be adjusted in the Settings Menu, to match your local reporting station.

# WEATHER FORECAST ICONS

- The Weather Forecast Icons are determined by the station's barometric pressure reading. Please allow 7-10 days for barometric calibration.
- This is your pressure at your stations' location and may vary slightly from your local reporting station.
- Six forecast icons use changing atmospheric pressure to predict weather conditions for the next 12-hours with 70-75% accuracy.
- When Outdoor temperature is below 32°F and the forecast is RAIN or T-STORM, the station will display SNOW.

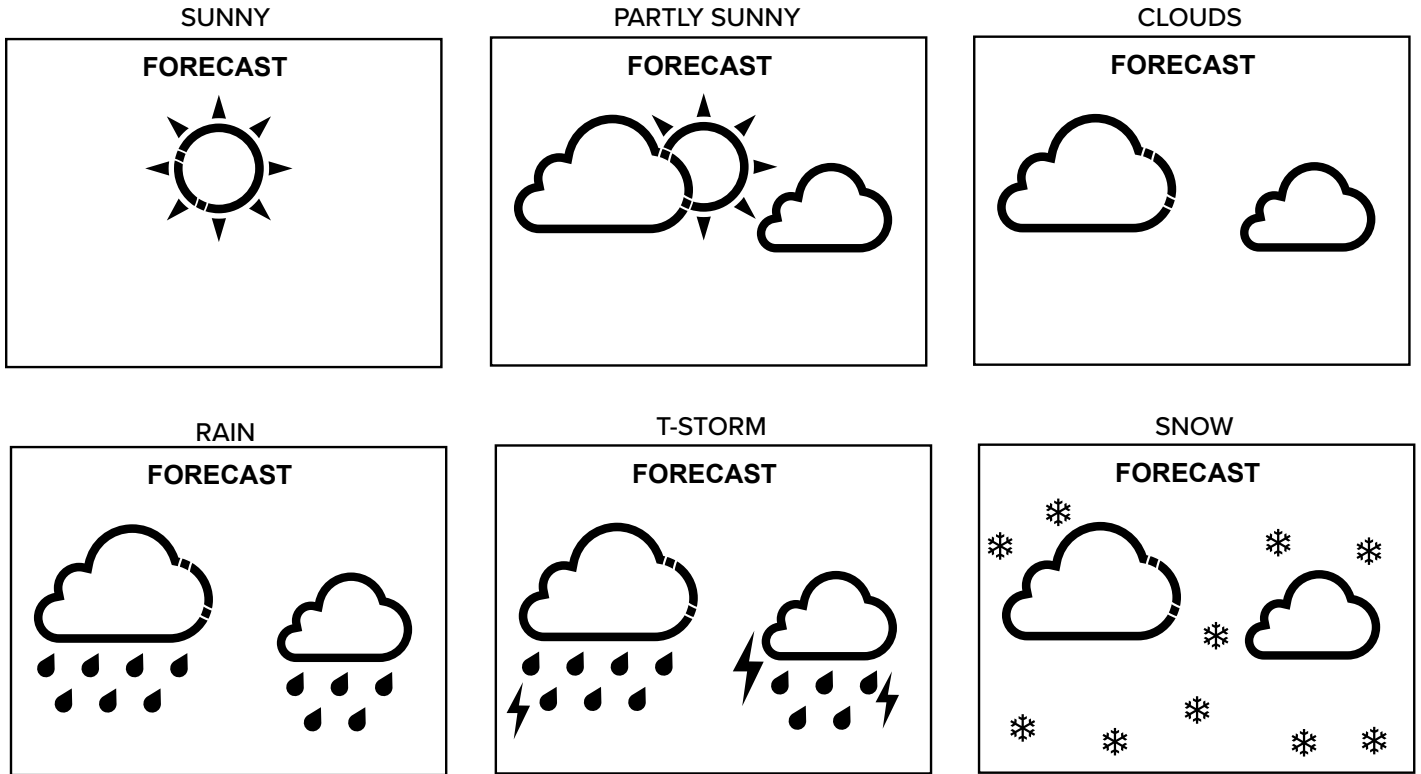

# HI/LO TEMPERATURE & HUMIDITY RECORDS

All HI/LO temperature/humidity records reset automatically at 12:00 (midnight).

- Press the TEMP button once to view HI indoor and outdoor temperature/humidity records.
- Press the TEMP button a second time to view LO indoor and outdoor temperature/humidity records.
- Press the TEMP button a third time to view outdoor Heat Index.
- Press the TEMP button a fourth time to view outdoor Dew Point.
- Press the TEMP button again to return to normal display.

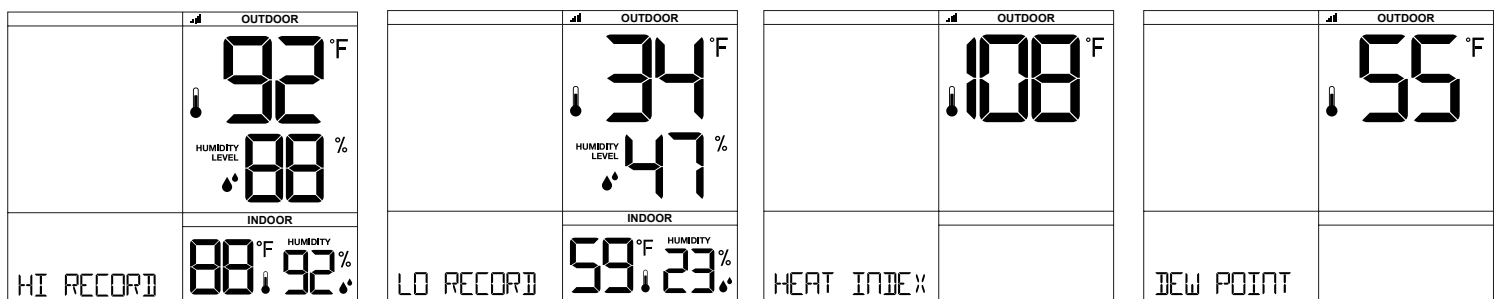

# TEMPERATURE & HUMIDITY ALERTS

## To set alerts:

1. Hold the ALERTS button to enter alert set mode.
2. Outdoor HI temperature alert OFF will show.
3. If you wish **to set** this alert value, press the + or – buttons to arm this alert (ON).
4. When the alert is armed (ON) the alert value will flash (no additional button press)
5. Press the + or – buttons to change the alert value.
6. Press the ALERTS button to confirm and move to the next alert.
7. If you **do not wish to set** an alert, press the ALERTS button again to move the next alert.  
(When the alert is OFF (disarmed) press ALERTS button to skip setting that alert value).
8. Press and release the ALERTS button until you get to the alert you wish to set.
9. To set the alert, first press the + or – buttons to turn the alert ON (armed).
10. When the alert is armed (ON) the alert value will flash (no additional button press)
11. Press the + or – buttons to change the alert value.
12. Press the ALERTS button to confirm and move to the next alert. Or press the LIGHT button to exit.

### Outdoor Temperature Alerts

OUTDOOR		OUTDOOR	
			40°F
OFF		ON	
LO ALERT		LO ALERT	
OUTDOOR		OUTDOOR	
			140°F
OFF		ON	
HI ALERT		HI ALERT	

### Outdoor Humidity Alerts

OUTDOOR		OUTDOOR	
HUMIDITY LEVEL		HUMIDITY LEVEL	10%
OFF		ON	
LO ALERT		LO ALERT	
OUTDOOR		OUTDOOR	
HUMIDITY LEVEL		HUMIDITY LEVEL	99%
OFF		ON	
HI ALERT		HI ALERT	

### Indoor Temperature Alerts

INDOOR		INDOOR	
			32°F
OFF		ON	
LO ALERT		LO ALERT	
INDOOR		INDOOR	
			99°F
OFF		ON	
HI ALERT		HI ALERT	

### Indoor Humidity Alerts

INDOOR		INDOOR	
HUMIDITY		HUMIDITY	10%
OFF		ON	
LO ALERT		LO ALERT	
INDOOR		INDOOR	
HUMIDITY		HUMIDITY	99%
OFF		ON	
HI ALERT		HI ALERT	

### Active Alert:

- The alert icon  will only show when the alert is active, and indicate HI or LO.
- When armed alert value is reached, station will beep 5 times, once each minute, until out of alert range.
- The flashing alert icon will indicate whether it is a LO or HI alert.
- Press any button to stop the temp alert sound.
- The alert icon will still flash while value is in alert range.

### Disarm Alert:

1. Hold the ALERTS button to enter alert setting menu.
2. Press the ALERTS button until you see the alert you wish to disarm.
3. Press the + or - button to disarm the alert. The alert will not sound.
4. Press the SEARCH button to exit.

## TEMPERATURE & HUMIDITY TREND ARROWS

- The UP and DOWN arrows indicate changes in temperature and humidity over the past hour.
- The arrows will update every 15 minutes and compare data from exactly one hour prior.

Temperature: arrow changes every 2 degrees Fahrenheit.

Humidity: arrow changes every 3% RH



## SENSOR SEARCH

- If you are seeing dashes in place of outdoor temperature, first check your sensor batteries.
- Hold the SENSOR button for 3 seconds to search for the sensor. Sensor Reception icon will flash while searching and be solid when sensor signal is received.
- If you regain connection while the sensor is mounted, great. If you do not regain connection, bring the sensor within 10 feet of the station and search again.

### Note:

- If the signal is lost, the RX will display the last data recorded from sensor for 10 minutes.
- After that 10 minutes if the signal does not come back then you will see dashes "--".
- After 30 minutes, start looking for the sensor signal automatically.



## CHANGE BATTERIES

We designed this station for convenience, so that a simple change of batteries does not lose your data or require you to power down your station.

### Sensor:

1. When Battery Indicator shows next to the Outdoor Temperature, replace batteries in your Outdoor Sensor.
2. Then hold the SENSOR button for 3 seconds and your station will search for your sensor.

### Station:

1. When Battery Indicator shows next to the Indoor Humidity, change batteries in the station.
2. When changing the batteries in the station, continue using the power cord. After replacing the batteries, no other action is needed. The batteries in the station only maintain time/date in the event of a power outage.

## FACTORY RESTART

A factory restart of the station returns it to default settings, and “out of the box” condition and may resolve connection issues.

1. Be sure there are fresh batteries in the sensor and station.
2. Hold the ALERTS and LIGHT button together for 5 seconds to restart the station. This will clear all settings and history. Station will automatically search for sensor.

## SENSOR WEATHER SHIELD-NOT INCLUDED

The Sensor Weather Shield is designed to protect your outdoor sensor from rain and snow. This shield will offer limited protection from the sun’s heat. Purchase at: <http://bit.ly/925-1418>



## WE'RE HERE TO HELP!

If you require additional support, call our customer support team based out of La Crosse, Wisconsin.

Phone: 1.608-782-1610

Or fill out our online support request form here: [bit.ly/contact\\_techsupport](https://bit.ly/contact_techsupport)

Our knowledgeable support team is available: Monday-Friday, 8am-6pm CST

## JOIN THE CONVERSATION

Ask questions, watch detailed setup videos, and provide feedback on our social media outlets!



## CARE AND MAINTENANCE

- Do not mix old and new batteries.
- Do not mix Alkaline, Standard, Lithium, or Rechargeable batteries.
- Always purchase the correct size and grade of battery most suitable for intended use.
- Replace all batteries of a set at the same time.
- Clean the battery contacts and also those of the device prior to battery installation.
- Ensure the batteries are installed with correct polarity (+ and -).
- Remove batteries from equipment which is not to be used for an extended period of time.
- Promptly remove expired batteries.

## SPECIFICATIONS

### INDOOR:

**Temperature Range:** 32°F to 99°F (0°C to 37°C)

- When above 99°F (37°C) temperature shows “HI”;
- When below 32°F (0°C) temperature displays “LO”.

**Humidity Range:** 10% to 99% RH

**Update Interval:** About every 60 seconds

**Relative Pressure Range:** 23.62 to 32.48 inHg (800 to 1100 hPa)

**Update Interval:** About every 12 minutes

### OUTDOOR:

**Temperature Range:** -40°F to 140°F (-40°C to 60°C)

**Humidity Range:** 10% to 99% RH

**Update Interval:** About every 51 seconds

**Transmission Range:** over 330 feet (100 meters) in open air RF 433MHz

### POWER REQUIREMENTS:

308-1417BLv2: AC6: GPU280500150WA00 (required) Optional: 3 “AA” LR6 Batteries (not included)  
TX141TH-Bv3: 2 “AA” LR6 Batteries (not included)

### BATTERY LIFE

308-1417BLv2: over 12 months with reputable batteries

TX141TH-Bv3: over 24 months with reputable batteries

### DIMENSIONS:

308-1417BLv2: 6.88” L x 1.25” W x 6.42” H (17.5cm L x 3.2 cm W x 16.3cm H)

TX141TH-Bv3: 1.57” L x 0.82” W x 5.11” H (3.98cm L x 2.08cm W x 12.98cm H)

## WARRANTY INFO

La Crosse Technology, Ltd. provides a 1-year limited time warranty (from date of purchase) on this product relating to manufacturing defects in materials & workmanship.

For Full Warranty Details, Visit: [www.lacrossetechnology.com/support](http://www.lacrossetechnology.com/support)

## FCC STATEMENT

This equipment has been tested and found to comply with the limits for a Class B digital device, pursuant to part 15 of the FCC Rules. These limits are designed to provide reasonable protection against harmful interference in a residential installation. This equipment generates, uses and can radiate radio frequency energy and, if not installed and used in accordance with the instructions, may cause harmful interference to radio communications. However, there is no guarantee that interference will not occur in a particular installation. If this equipment does cause harmful interference to radio or television reception, which can be determined by turning the equipment off and on, the user is encouraged to try to correct the interference by one or more of the following measures:

- Reorient or relocate the receiving antenna.
- Increase the separation between the equipment and receiver.
- Connect the equipment into an outlet on a circuit different from that to which the receiver is connected.
- Consult the dealer or an experienced radio/TV technician for help.

This device must not be co-located or operating in conjunction with any other antenna or transmitter.

**Operation is subject to the following two conditions:**

- (1) This device may not cause harmful interference, and
- (2) This device must accept any interference received, including interference that may cause undesired operation.

### **Caution!**

The manufacturer is not responsible for any radio or TV interference caused by unauthorized modifications to this equipment. Such modifications could void the user authority to operate the equipment.

All rights reserved. This manual may not be reproduced in any form, even in part, or duplicated or processed using electronic, mechanical or chemical process without the written permission of the publisher. This booklet may contain errors or misprints. The information it contains is regularly checked and corrections are included in subsequent editions. We disclaim any responsibility for any technical error or printing error, or their consequences.

All trademarks and patents are recognized.

 **WARNING:** This product can expose you to chemicals including styrene, which is known to the State of California to cause cancer. For more information go to: [www.P65Warnings.ca.gov](http://www.P65Warnings.ca.gov)